

Birds

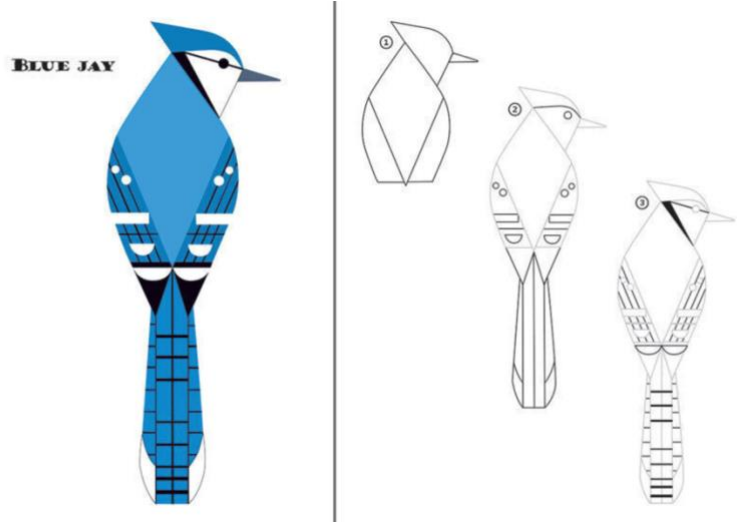

Hello My Most
Amazing
Artists!



How are
You Today?

Our Lesson this week is all about Birds. Ms. Bell, our amazing science teacher, and I decided to work together this week on a theme. So this week in science you will be learning about local birds, and I thought we should use that inspiration for our art as well. The challenge is this week to use a local bird, one found in Utah, and bonus points if you actually see that kind this week as you are outside. There are lots of options in this lesson, you get to choose to do one or all of them. Have fun and keep creating!

Don't Forget to send me a photo of your creations at jenny.davis@slcschools.org I will upload any Bonneville artists work to our new Instagram gallery @bonnevilleamazingartists. I can't wait to see what you are creating

Materials List...

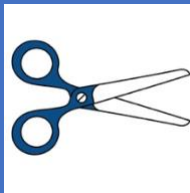

Charley Harper Birds

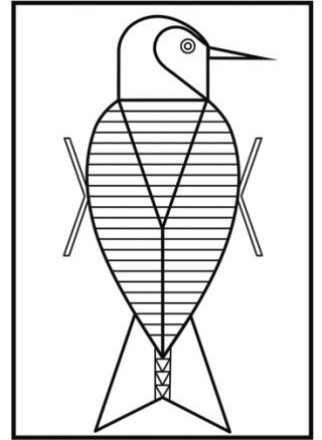
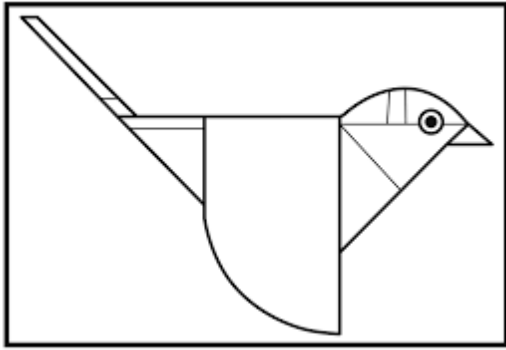

In a style he called "minimal realism", Charley Harper captures the essence of his subjects with the fewest possible visual elements. When asked to describe his unique visual style, Charley responded: "When I look at a wildlife or nature subject, I don't see the feathers in the wings, I just count the wings. I see exciting shapes, color combinations, patterns, textures, fascinating behavior and endless possibilities for making interesting pictures. I regard the picture as an ecosystem in which all the elements are interrelated, interdependent, perfectly balanced, without trimming or unutilized parts; and herein lies the lure of the painting; in a world of chaos, the picture is one small rectangle in which the artist can create an ordered universe."





CARDINAL



BLUE JAY

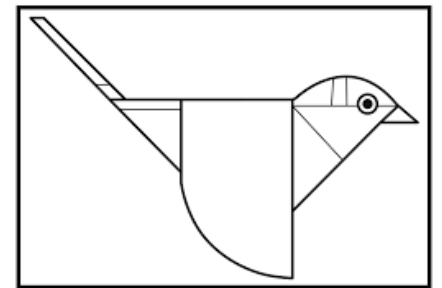
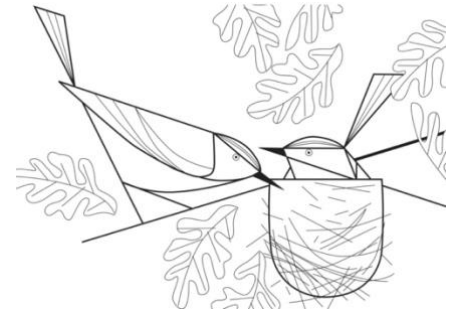
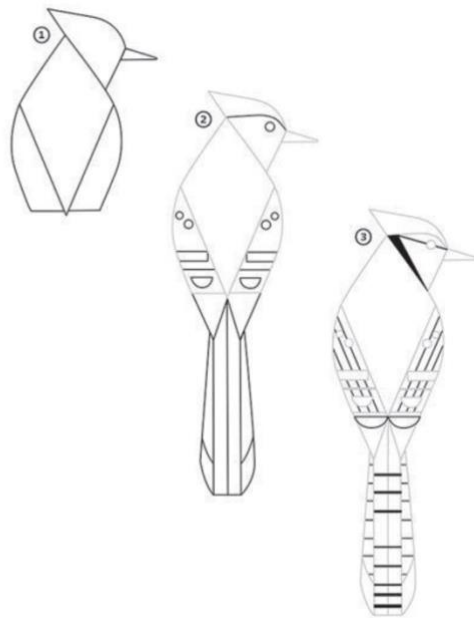
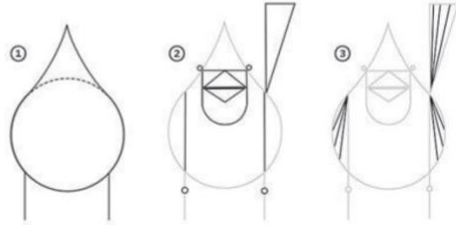
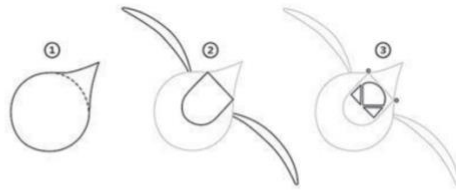

Draw and color your own Charley Harper Style bird...

OR follow along with this cut paper collage Charley Harper Style bird...

<https://www.youtube.com/watch?v=J3YwH1Ko9NE>



Origami Bird Puppet



How To video...

https://www.youtube.com/watch?time_continue=8&v=NsjTXXzIXEk&feature=emb_logo



How To Draw a Bird

1 Draw a curved line for the head



2 Add a circle for the eye and a beak

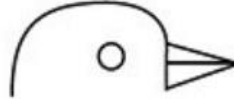

3 Draw a straight line for the bird's back and a smooth curved line for the belly.

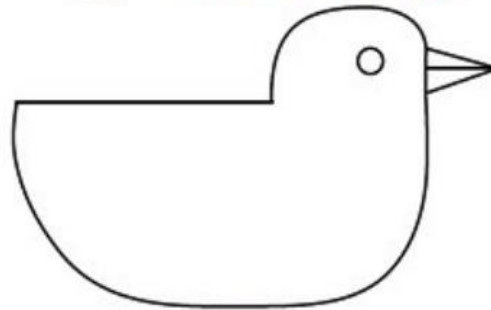

4 To make a tail, draw 4-5 straight or curly lines at the back of the bird.

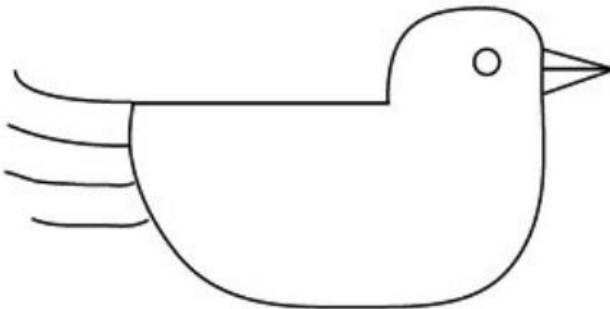

5 Connect the tail lines together so that the tips are smooth. Or you could make a pointy tail by connecting the lines with an angle line. Now add two angle lines for the wing.

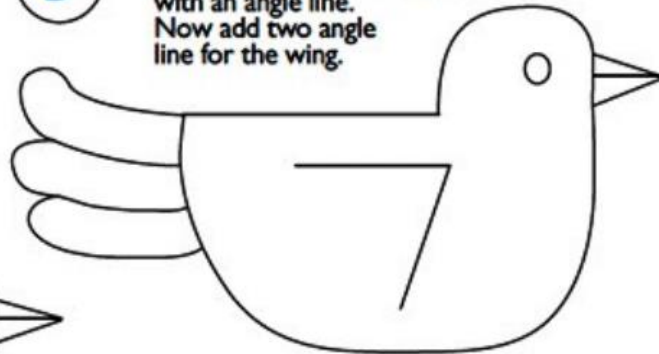

6 Connect the ends of these two lines with any shape you like: scallop lines, wavy lines, feathery lines, zig-zag.

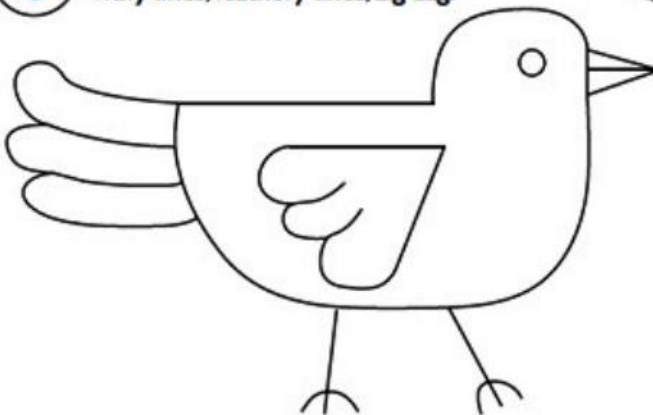

How to Draw a

BIRD

by Deep Space Sparkle

Drawing Tips:

Use an oil pastel or crayon to draw the bird. Children will naturally draw big and the temptation to erase or fix their "mistakes" will be reduced.

Instead, encourage children to draw together and keep going if they think they don't like a line. At the end of the lesson, the children can opt to keep their drawing or start again on the other side.

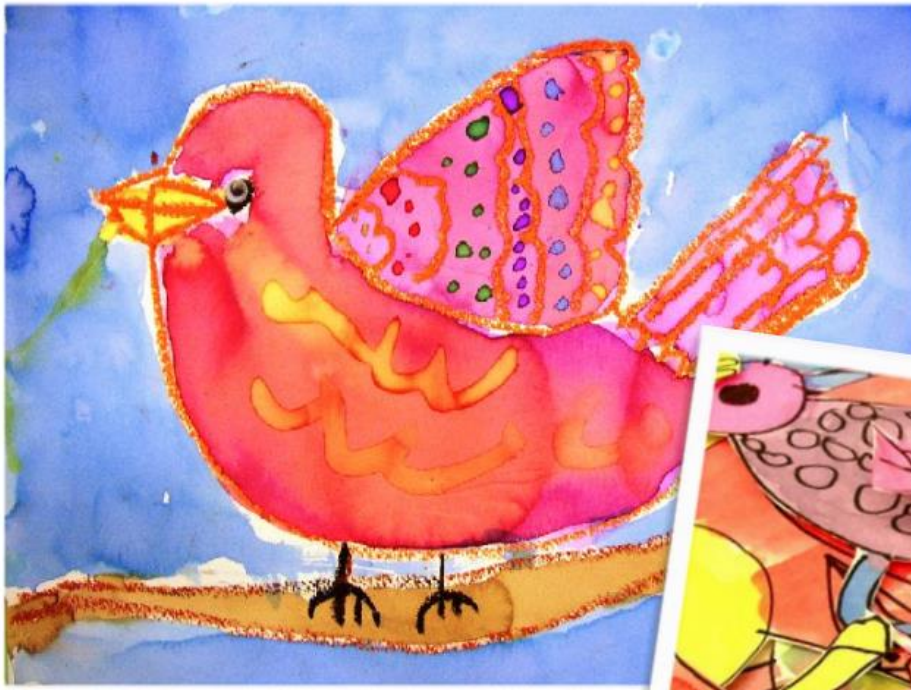

< FIRST GRADE BIRDS
oil pastels with liquid
watercolor on 90-lb watercolor
paper



KINDER BIRDS >
Sharpie marker and liquid
watercolors on drawing paper



< FIRST GRADE BIRDS
oil pastels and tempera paint
(mixed with a bit of white paint)
on black paper

Draw a Bald Eagle

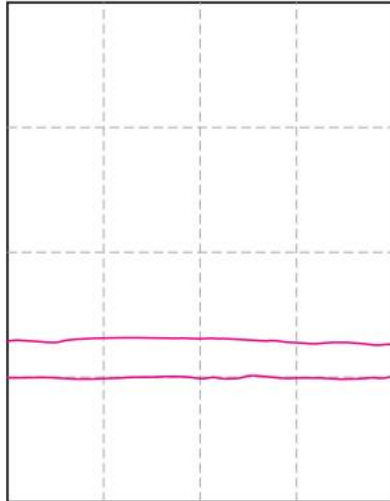

1. Make guidelines. Draw a branch.

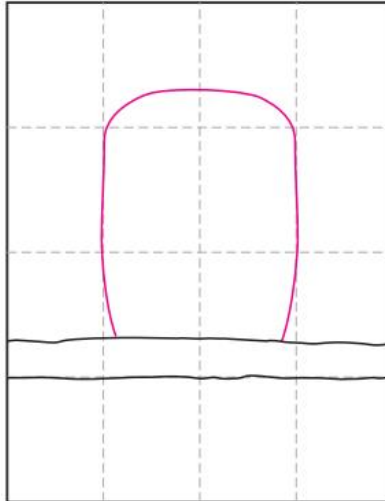

2. Start the body.

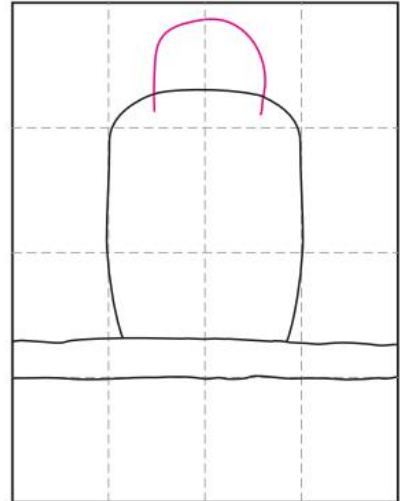

3. Draw the top of the head.

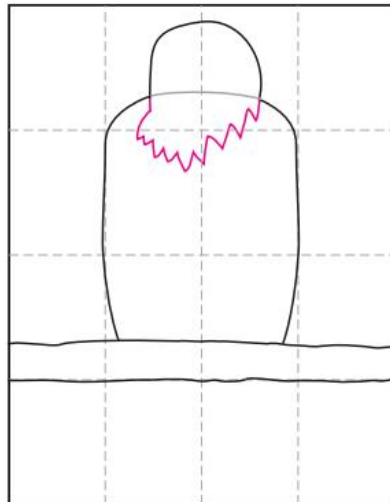

4. Draw the bottom feathers.

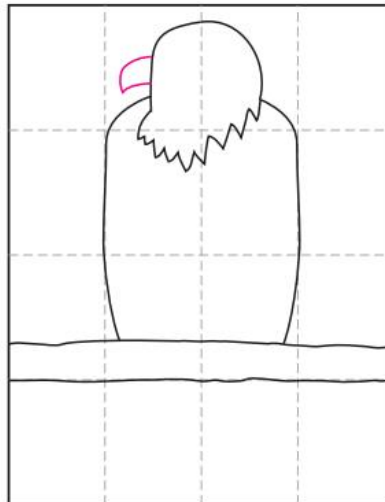

5. Add the beak.

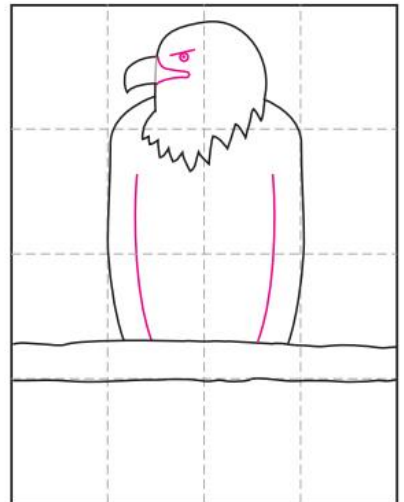

6. Finish the face, add wing lines.

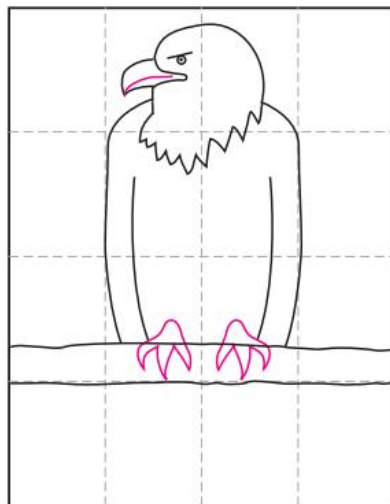

7. Finish beak. Draw two feet.

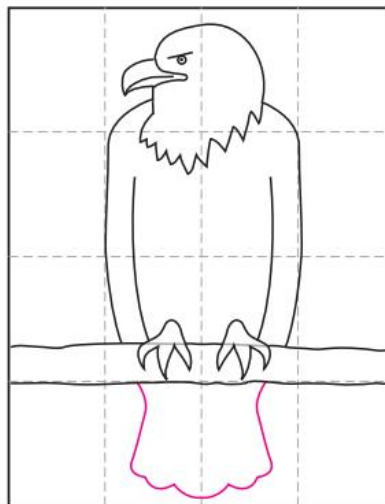

8. Erase inside of feet. Add a tail.



9. Trace and paint or color.

Hummingbird Collage



1- Print off template (see next page)

2- Color in pieces

- Use watercolor paints
- Or crayons
- Or cardboard and recycled materials
- Or tissue paper.

3- Let dry and then cut out pieces and assemble on a separate background paper.

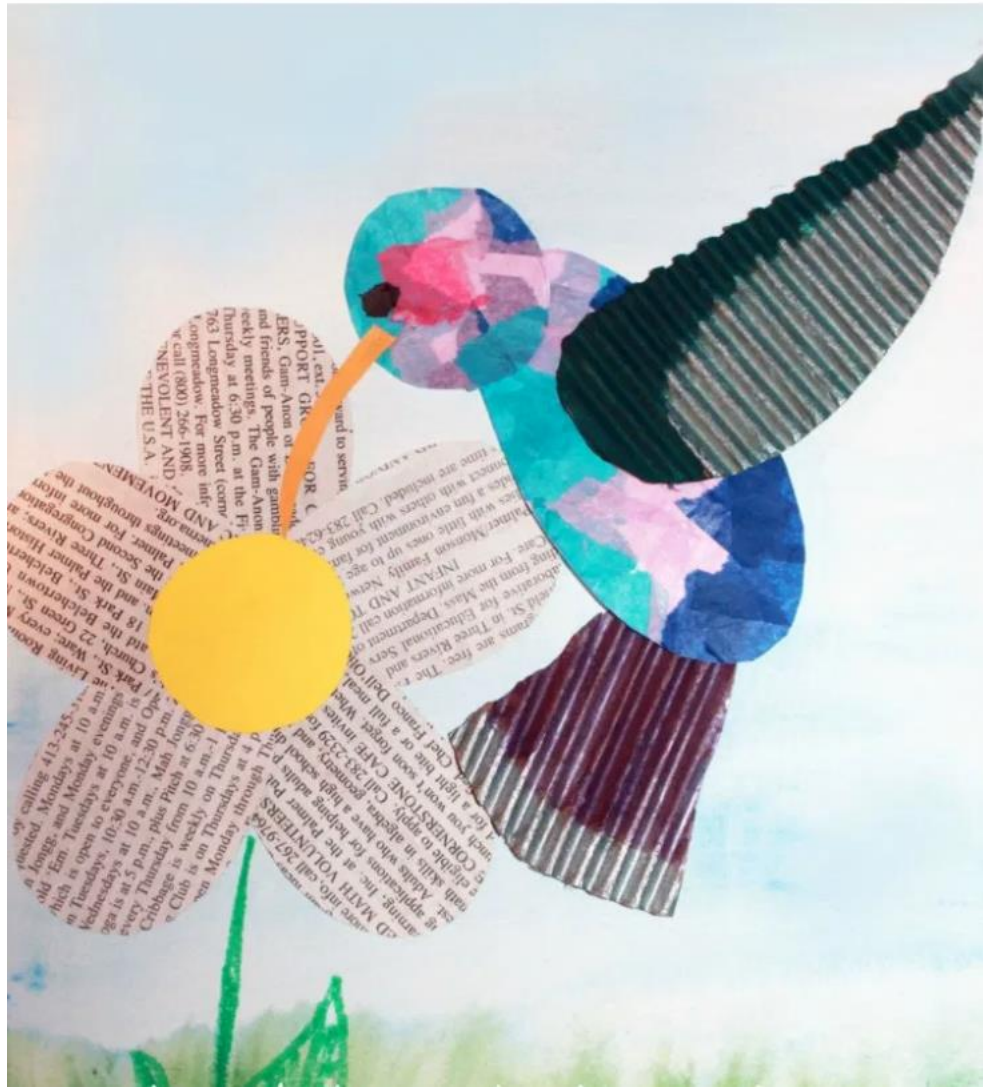

Hummingbird collage template

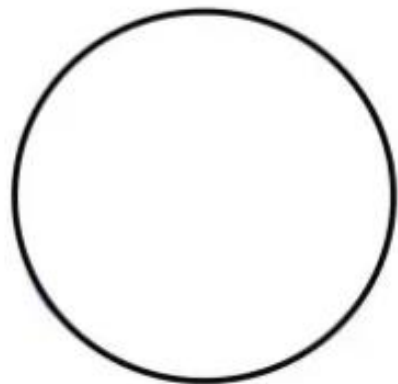
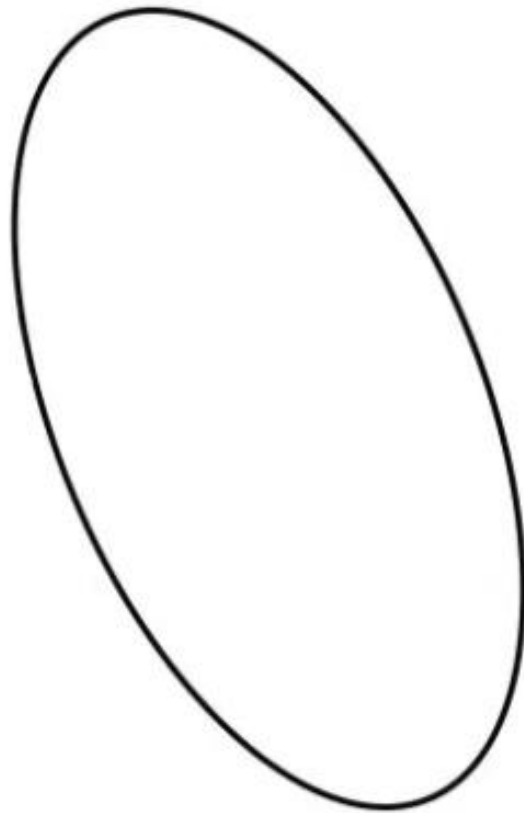
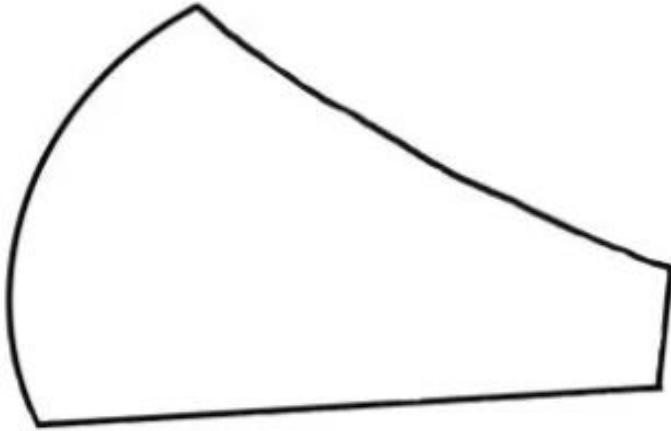

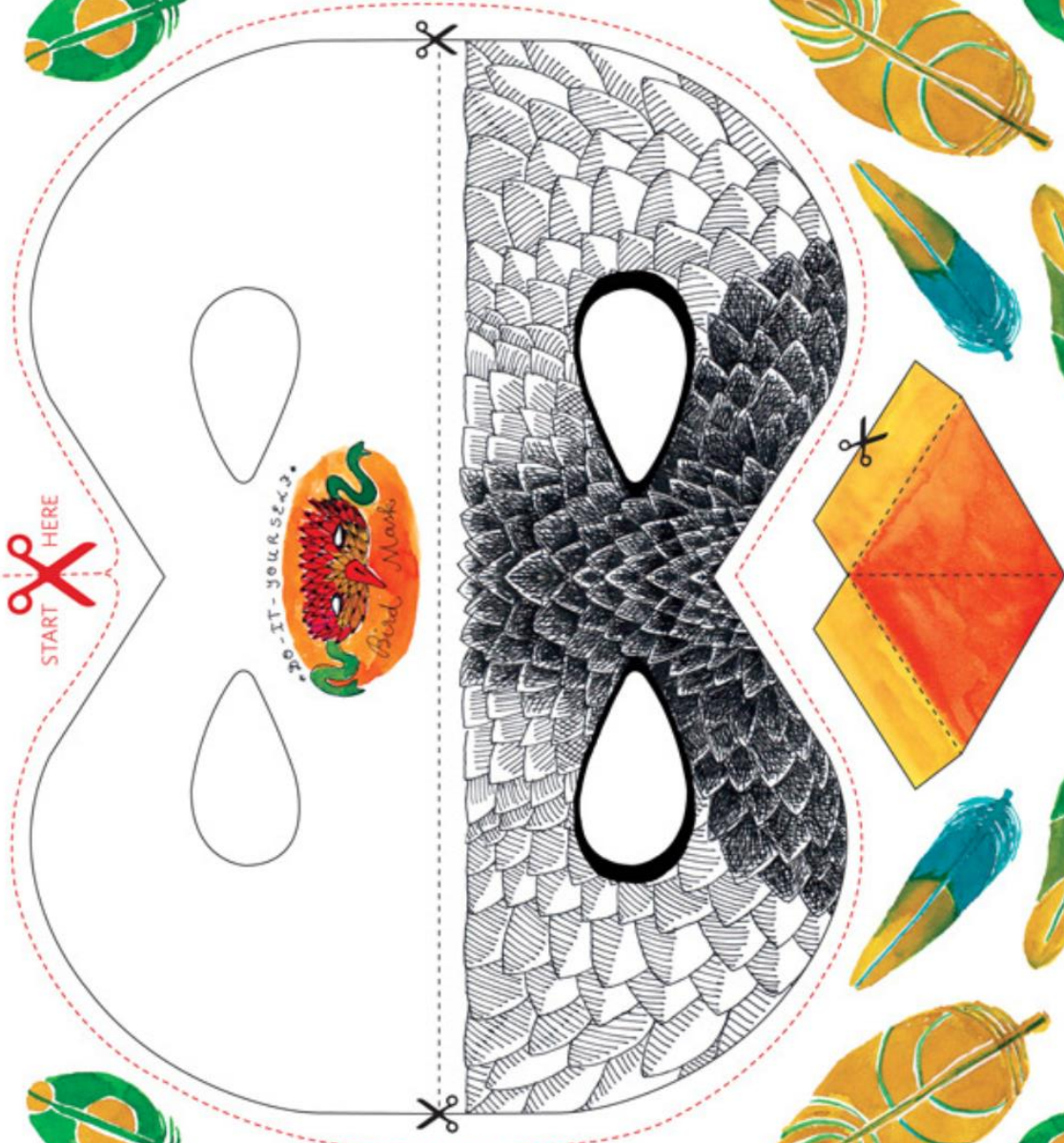

START HERE



Wildlife Week 2013
CONCEPT & DESIGN: Nandini Velloo & Anupa Narayana

Eaglenest
Wildlife Sanctuary



Giant Cardboard Bird



Color them. When they are dry glue them.

You need:

1-big cardboard pieces
(we used some [IKEA](#) packaging)

2-scissors, pencils, and
tempera/acrylic paints

3-strong glue and stapler

- Draw and cut out shapes
- Paint or color
- Glue and staple
- Add bold black outlines for details.

